

SPOTUNE OMNI

WIRELESS OMNIDIRECTIONAL SPEAKER



User manual

INDEX

1	Important remarks	Page 4
2	Important safety instructions	Page 6
3	Introduction	Page 8
4	Setting up	Page 10
5	Packaging content	Page 12
6	Technical specifications	Page 13
7	Compliance & License	Page 14

1 . IMPORTANT REMARKS



The lightning flash with arrowhead symbol, within an equilateral triangle, is intended to alert the user to the presence of uninsulated “dangerous voltage” within the product’s enclosure that may be of sufficient magnitude to constitute a risk of electric shock to persons.



The exclamation point within an equilateral triangle is intended to alert the user to the presence of important operating and maintenance (servicing) instructions in the literature accompanying the appliance.

WARNING

(If applicable): The terminals marked with symbol of “ ” may be of sufficient magnitude to constitute a risk of electric shock. The external wiring connected to the terminals requires installation by an instructed person or the use of ready-made leads or cords.

WARNING

To prevent fire or shock hazard, do not expose this equipment to rain or moisture.



Class II (2) appliance

WARNING This product must not be discarded, under any circumstance, as unsorted urban waste. Take to the nearest electrical and electronic waste treatment centre.



NOTE Spottune company accepts no liability for any damage that may be caused to people, animal or objects due to failure to comply with the warnings above.

2. IMPORTANT SAFETY INSTRUCTIONS

1. Read these instructions.
2. Keep these instructions.
3. Heed all warnings.
4. Follow all instructions.
5. Do not use this apparatus near water.
6. Clean only with dry cloth.
7. Do not block any ventilation openings. Install in accordance with the manufacturer's instructions.
8. Do not install near any heat sources such as radiators, heat registers, stoves, or other apparatus (including amplifiers) that produce heat.
9. Do not defeat the safety purpose of the polarized or grounding. If the provided track adapter or cord, does not fit into your outlet, consult an electrician for replacement of the obsolete outlet.
10. Protect the power cord from being walked on or pinched particularly at the plugs, convenience receptacles, and at the point where they exit from the apparatus.
11. Only use attachments/accessories specified by the manufacturer.
Unplug the apparatus during lightening shorts or when unused for long periods of time. Refer all servicing to qualified personnel. Servicing is required when the apparatus has been damaged in any way, such as power supply cord or plug is damaged, liquid has been spilled or objects have fallen into the apparatus, the apparatus has been exposed to rain or moisture, does not operate normally, or has been dropped.

Disconnecting from mains:

Spotttune Omni Track only:

Switching off the TRACK ADAPTOR GLOBAL GA 69 all the functions and light indicators of the SpotTune Omni will be stopped and fully disconnected from mains is done. TRACK ADAPTER GLOBAL GA 69 connects with the Nordic Aluminium Lighting Track system. Nordic Aluminium Lighting Track system must be connected and controlled by a circuit breaker which rated current is not more than 10A and rated voltage is AC 100-240V.

Spotttune Omni Cord only:

Switch off power, before disconnecting Spotttune OMNI Cord from mains.

- 12.** Equipment is connected to a socket-outlet with earthing connection by means of a power cord.
- 13.** The marking information is located at the bottom of apparatus.
- 14.** The apparatus shall not be exposed to dripping or splashing and that no objects filled with liquids, such as vases, shall not be placed on the apparatus.

3. INTRODUCTION

Spottune Omni

The Spottune Omni speaker is acoustically designed to radiate sound in all directions whereas a traditional loudspeaker is optimized toward a frontal listening position "Sweet spot listening".

The 360° sound radiation is advantageous in environments where the aim is to evenly distribute the sound to give the same listening experience across the room.

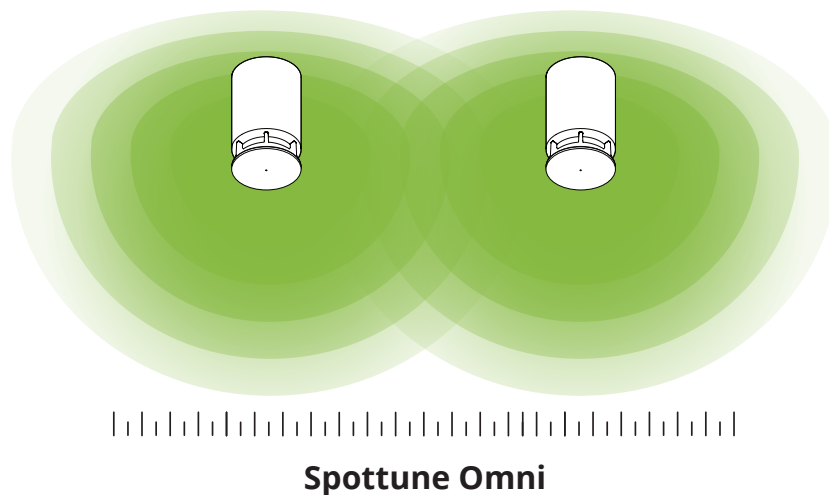
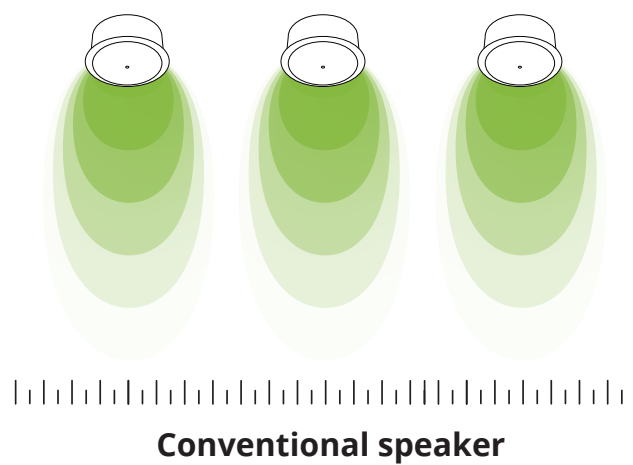

The speaker system with blending acoustics, for a balanced soundscape - unique sound - optimal comfort - best experience. The 360° sound radiation is obtained by an acoustic lens and digital signal processing.

1. Status LED
2. USB Port for service, and update
3. Zone button. Switch between zone I and II
4. Zone indicator. LED lights to indicate if speaker is connected to zone I or II
5. Pair button. For pairing speaker with Spottune Stream - Transmitter

STATUS LED Lights

- No light** No power connected to the speaker
- WHITE light** Booting up
- GREEN flash** Speaker is in pairing mode / process
- GREEN light** Connection established / ready
- RED flash** No connection to Spottune Stream
- RED light** Standby, no music signal from stream.
- YELLOW flash** Reset to factory default

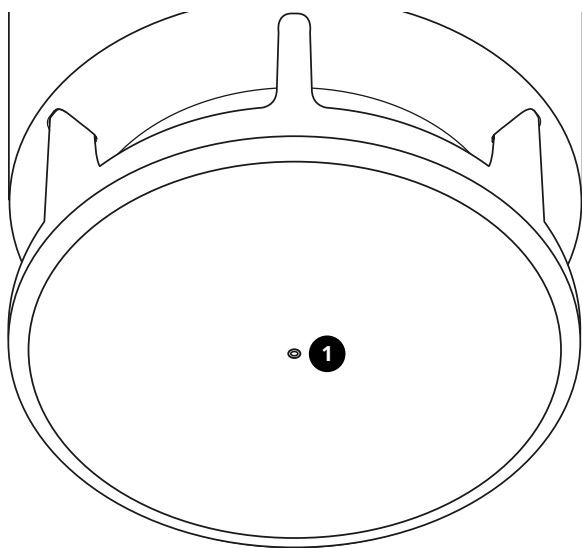

FRONT

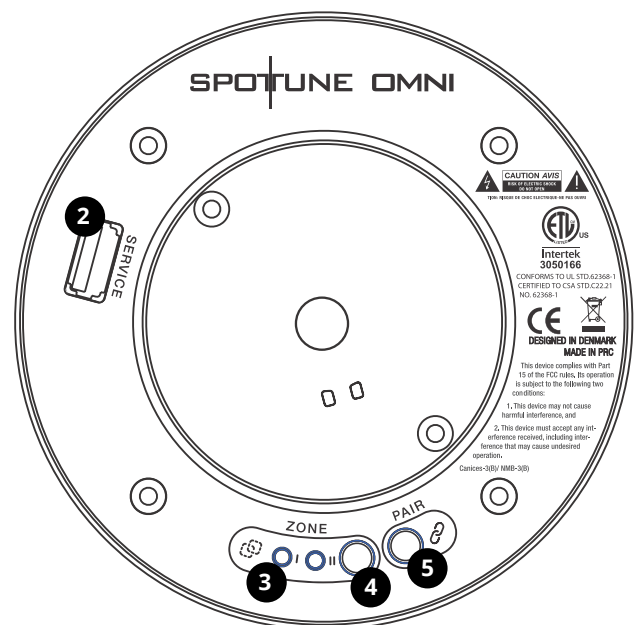

BACK

4. SETTING UP

Placement

- Place Spottune Omni speaker within reach of Spottune Stream transmitter.
- Place Spottune Omni speaker, high, freely and visible, not in closed compartments. Avoid placing near or with blocking metal materials around of Spottune Omni speaker.

Installation: Spottune Omni - TRACK

WARNING WHEN INSTALLING, ALWAYS OBSERVE THE NATIONAL INSTALLATION AND ACCIDENT PREVENTION REGULATIONS

WARNING TRACK ADAPTOR GLOBAL GA 69 Use only supplied adaptor. Speaker loudspeaker is not suitable for 12 V tracks.

WARNING NORDIC ALUMINIUM LIGHTING TRACK SYSTEMS
It is forbidden to use any kind of solvent, glue, grease, oil or cleaner et. in contact with Nordic Aluminium adapters or other lighting track components. These foreign materials can cause cracking and/or damage to the components for which, Nordic aluminium will not be liable for.

Unbox and connect Spottune Omni speaker to power source, at its final placement, following the instructions below. Choose the phase (1, 2 or 3) before fastening into the track or afterwards.

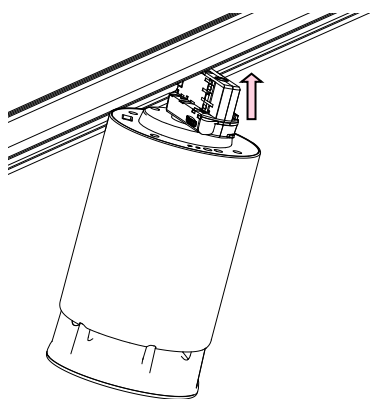

1. Align and place in track

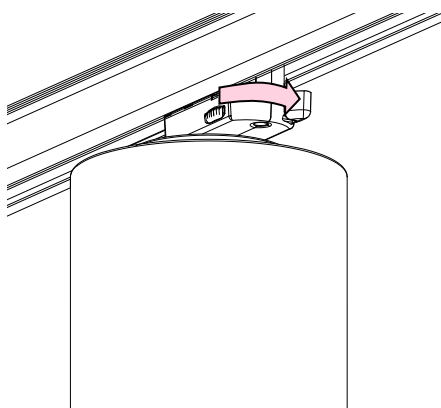

2. Secure in track, with latch

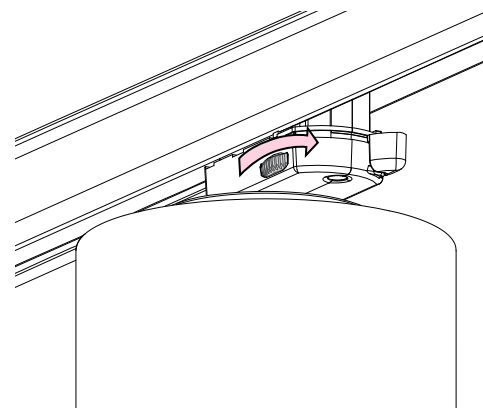

3. Choose phase on dial

Installation: Spottune Omni - CORD

- Cord comes equipped with a pre-mounted double insulated 2 wired cord (“Live” & “Neutral”) and is a Class II appliance.

Setting up

- Spottune Omni speaker is automatically in “PAIRING MODE” when powering up the first time the “Status LED” is flashing green on the front of the speaker.
- Spottune Omni is automatically installed as “ZONE 1” - if you want to change the speaker to “ZONE 2” press & hold for 2 sec “Zone button” on Spottune Omni speaker, to toggle between “ZONE 1” and “ZONE 2”.
- After powering up the Spottune speaker(s), power on your Spottune Stream. Spottune Stream is automatically in “PAIRING MODE” when powering on the first time, and will pair the Spottune Omni speaker(s) to the chosen zone(s).

Factory Reset

- Press “Zone button” on Spottune Omni Speaker and hold for 30 seconds to factory reset Spottune Omni speaker, the “Status LED” will flash yellow to confirm the reset

5. PACKAGING CONTENT

Spottune Omni packaging contains:

- 1x Spottune Omni speaker
 - For TRACK: Mounted with TRACK ADAPTOR GLOBAL GA 69
 - For CORD: Mounted with 5 meter, double insulated cord.
- User Manual

6. TECHNICAL SPECIFICATIONS

Colors	White / Black / Grey
Specifications	Wireless Smart Speaker, Digital amplification DSP Bass extension Full-tone closed box system Acoustic 3D design Omni (360°) Sound radiation Powerful 4-inch extended range-driver Plug n' Play
Frequency	Audio frequency range 50-15000Hz Max SPL 100dB
Amplification	~50W digital class D amplifier
Wireless Features	Digital-Audio-Broadcasting-Technology RF-Band 1,8-1,9 GHz Range up to 50-100m (Condition dependent)
Dimensions	Diameter: 115 mm Height: 200 mm
Weight	1,5 Kg
Power consumption	1,74W (Limitation 2W)
SKU	O1-T-W / O1-T-B / O1-T-G O1-C-W / O1-C-B / O1-C-G O1-R-W / O1-R-B / O1-R-G

7. COMPLIANCE & LICENSE

This device complies with Part 15 of the FCC Rules. Operation is subject to the following two conditions:

1. This device may not cause harmful interference, and -
2. This device must accept any interference received, including interference that may cause undesired operation.

NOTE: This product has been tested and found to comply with the limits for a Class B digital device, pursuant to Part 15 of the FCC Rules. These limits are designed to provide reasonable protection against harmful interference in a residential installation. This product generates, uses, and can radiate radio frequency energy and, if not installed and used in accordance with the instructions, may cause harmful interference to radio communications. However, there is no guarantee that interference will not occur in a particular installation. If this product does cause harmful interference to radio or television reception, which can be determined by turning the equipment off and on, the user is encouraged to try to correct the interference by one or more of the following measures:

- Reorient or relocate the receiving antenna.
- Increase the separation between the equipment and receiver.
- Connect the equipment into an outlet on a circuit different from that to which the receiver is connected.
- Consult the dealer or an experienced radio/TV technician for help.

Please take attention that changes or modification not expressly approved by the party responsible for compliance could void the user's authority to operate the equipment.

NOTE: This device contains licence-exempt transmitter(s)/receiver(s) that comply with Innovation, Science and Economic Development Canada's licence-exempt RSS(s). Operation is subject to the following two conditions:

1. This device may not cause interference.
2. This device must accept any interference, including interference that may cause undesired operation of the device.

Limited by local law regulations, version for North America does not have region selection option.

This equipment complies with FCC/IC RSS-102 radiation exposure limits set forth for an uncontrolled environment. This equipment should be installed and operated with minimum distance 20cm between the radiator & your body.

SPOTTUNE | Denmark

www.spottune.com